

## TB-17 TIME SWITCH

### OPERATION INSTRUCTIONS

Before operating this set, please adjust the selector located at the front left side of the body to the adequate frequency.

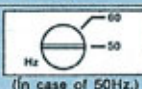

**(1) Set the time-setting pins at the desired times**  
Push the time-setting pins onto the dial position indicating the selected time.

- To turn the load on, use a red pin.
  - To turn the load off, use a white pin.
- Push the time-setting pin firmly into place.

**(2) Set the present time**  
Turn the dial to the right in the direction of the arrow until the present time position on the dial is aligned with the present time arrow.

**(3) Set the manual ON-OFF switch**  
Turn the manual ON-OFF switch to the right in the direction of the arrow to turn the load ON or OFF

(When the load is ON.)



(When the load is OFF.)



- When the load circuit continues ON or OFF for a long time, please operate manual ON-OFF switch after you have removed all time-setting pins.
- When the time-setting pin is within 1 hour of the present time, the manual ON-OFF switch should not be turned.

### SPECIFICATIONS

Model No.	TB-17		
Movement type	AC-type		
Rated Voltage	110V	200-220V	240V
Voltage Tolerance	85-120V	170-240V	220-260V
Frequency	50/60Hz(selection type)		
Power Consumption	1.5W		
Time precision	Same as AC frequency		
Ambient Temperature	~10°C~+50°C		
Resistive Load	250VAC 15A		
Lamp Load	100VAC 1500W 200VAC 3000W		
Inductive Load	10A (cosφ=0.7 or more)		
Motor Load	100VAC 750W 200VAC 1500W		
Minimum setting unit	15 minute units		
Minimum setting interval	30 minutes		
No. of ON-OFF operations	Standard 6 operations Maximum, 48 operations are possible		
Weight	270g		

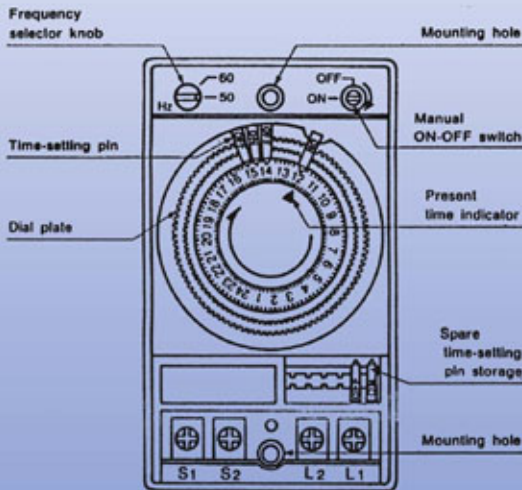

## ■ DIMENSIONS

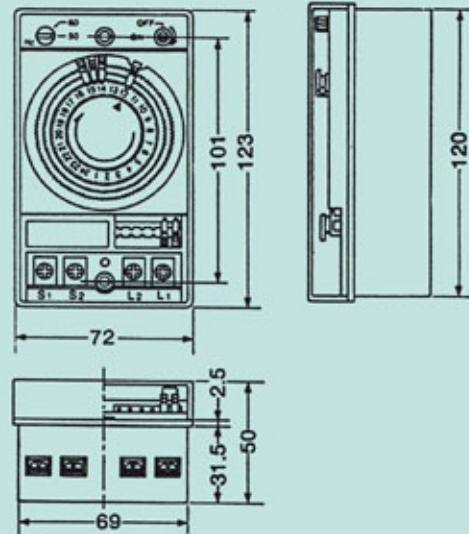

## REMOVING THE COVER

Pull out the cover pressing both side.

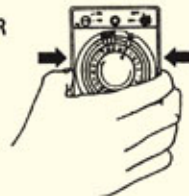

## ■ CAUTIONS

- To set the correct time turn the dial in the direction of the arrow (clockwise) and set the Present time.
- Please observe the rated voltage and voltage tolerance of the time switches for adequate use.
- If the load capacity exceeds the rating an electromagnet switch is required.
- Do not use the time switch where:
  - the ambient temperature goes below -10°C or above +50°C
  - there is much dust
  - there is much moisture
  - outdoors or where it will be exposed to rain or water
  - there is much vibration
- Do not forget to set to the correct time in case of a power outage due to the suspension of electric current.

## ■ WIRING CONNECTION DIAGRAM

When the time switch is used for loads exceeding the rated capacity, it is imperative that the time switch be used in combination with one or more magnetic contactors according to each load.

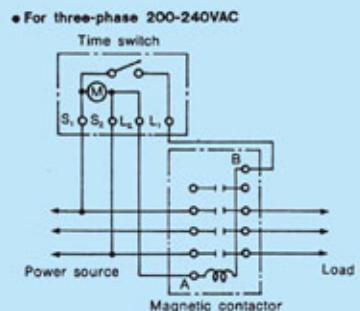
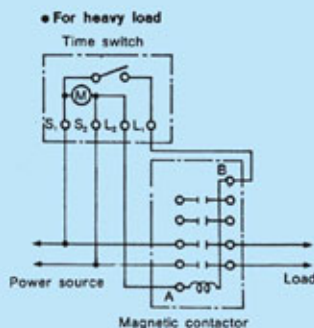
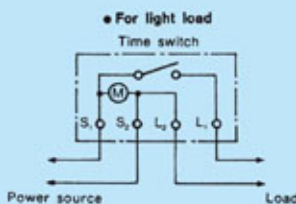

When the time switch is used with a heater, it is imperative that the load circuit be protected by a thermo-switch.