

## TWO HOLE HYLUG™ CODE CONDUCTOR LONG BARREL

TYPES YA-2N, YA-2TC,  
YA-4N

UL Listed 90° C,  
600 Volts to 35 KV ◆

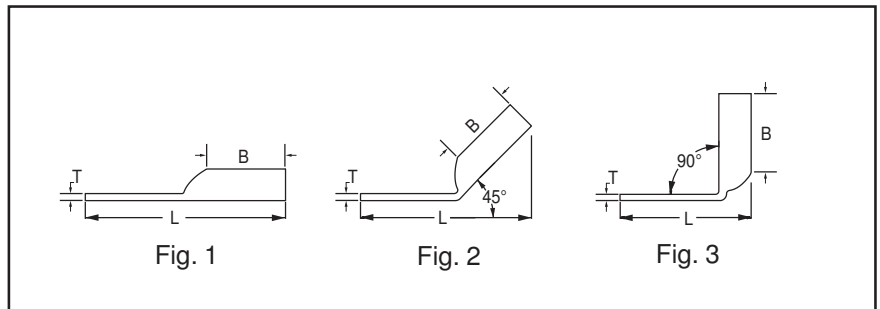
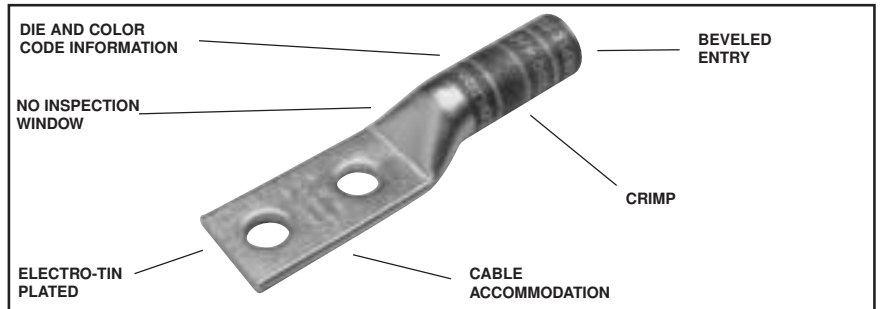

C-51

Catalog Number	Fig #	Conductor		Stud Hole Size	Stud Hole Spacing	Tongue Width	Figure Dimensions			Dieless (# of crimps)	▲ Installation Tooling				Wire Strip Length			
		AWG	*** MM <sup>2</sup>				(B)	(T)	(L)		Mechanical MD6, OUR840, MD7-34R	Hydraulic BCT500HS, Y500CTS	Y35, Y39, Y750, Y46*, PAT750	Color Code		Die Index		
YA8C2TC14	1	#8 STR.	†	1/4"	5/8"	.40"			2.33"	Y2MR (2) Y8MRB-1 (2) MY29-3 (2) MY29-11 (2) MRC840 (2)	W8CVT (2) W8CRT (2) X8CRT (2)	W8CVT (2) W8CRT (2) X8CRT (2)	U8CRT (1)	Red	49	1"		
YA8C2TC14-45	2					.40"	.81"	.08"	2.20"									
YA8C2TC14-90	3					.41"			1.49"									
YA8C2TC14E2	1			#6 SOL	10	1/4"	3/4"	.41"										2.45"
YA8C2TC14E2-45	2							.41"	.81"								.08"	2.33"
YA8C2TC14E2-90	3							.41"										1.62"
YA8C2TC38	1			37/24		3/8"	1"	.73"										2.89"
YA8C2TC38-45	2							.73"	.81"								.06"	2.72"
YA8C2TC38-90	3							.73"										2.05"
YA6C2N	1	#6 AWG	-	1/2"	1-3/4"	.81"			4.40"	Y1MR (2) Y2MR (2) MY29-3 (2) MY29-11 (2) MRC840 (2)	W5CVT (2) W5CRT (2) X5CRT (2) X8CART (2)	W5CVT (2) W5CRT (2) X5CRT (2) X8CART (2)	U5CRT (2) U8CABT (2)	Blue	7	1-3/16"		
YA6C2N-45	2					.81"	1.12"	.12"	4.29"									
YA6C2N-90	3					.81"			3.28"									
YA6C2TC14	1			1/4"	5/8"	.45"			2.65"									
YA6C2TC14-45	2					.45"	1.12"	.08"	2.45"									
YA6C2TC14-90	3					.45"			1.51"									
YA6C2TC14E1	1			1/4"	1"	.45"			3.03"									
YA6C2TC14E1-45	2					.45"	1.12"	.08"	2.83"									
YA6C2TC14E1-90	3					.45"			1.88"									
YA6C2TC14E2	1			1/4"	3/4"	.45"			2.78"									
YA6C2TC14E2-45	2					.45"	1.12"	.08"	2.58"									
YA6C2TC14E2-90	3					.45"			1.63"									
YA6C2TC38	1			3/8"	1"	.63"			3.22"									
YA6C2TC38-45	2					.63"	1.12"	.06"	2.97"									
YA6C2TC38-90	3					.63"			2.06"									
YA6C2TC38E2	1			3/8"	3/4"	.63"			2.97"									
YA6C2TC38E2-45	2					.63"	1.12"	.06"	2.72"									
YA6C2TC38E2-90	3					.63"			1.81"									
YA6C2TC38E6	1			3/8"	7/8"	.63"			3.09"									
YA6C2TC38E6-45	2					.63"	1.12"	.06"	2.85"									
YA6C2TC38E6-90	3					.63"			1.94"									

▲ See tooling section of this catalog for complete tool and die listings.

\* Use PUADP-1 adaptor with "U" -dies in Y46 HYPRESS™.

\*\* P-RT die sets for use in Y46 HYPRESS™ only, PUADP-1 adaptor not required.

\*\*\* The MM<sup>2</sup> conductor sizes listed are the recommendations for Class 2 conductor.

† The MM<sup>2</sup> conductor size listed here is for Class 2 and Class 5 conductor.

\* Available undrilled. Add suffix "U" to catalog number (example: YA25U).

◆ For applications greater than 2000 Volts consult cable manufacturer for voltage stress relief instructions.

## TWO HOLE HYLUG™ CODE CONDUCTOR LONG BARREL (Continued)

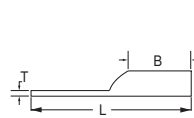

Fig. 1

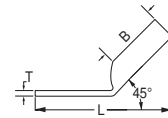

Fig. 2

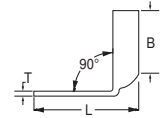

Fig. 3

C-52

Catalog Number	Fig #	Conductor		Stud Hole Size	Stud Hole Spacing	Tongue Width	Figure Dimensions			▲ Installation Tooling					Wire Strip Length		
		AWG	MM <sup>2</sup>				(B)	(T)	(L)	Dieless (# of crimps)	Mechanical		Hydraulic			Color Code	Die Index
											MD6, OUR840, MD7-34R	BCT500HS, Y500CTHS	Y35, Y39, Y750, Y46*, PAT750				
YA5C2N	1	5 AWG	-	1/2"	1-3/4"	.83"	1.12"	.12"	4.43"	MY29-3 (2) MY29-1 (2) MRC840 (2) Y644M (1)	W5CRT (2) W5CVT (2) X5CRT (2)	X5CVT (2) W5CRT (2)	U5CRT (2)	Blue	7	1-3/16"	
YA5C2N-45	2						1.12"	.12"	4.31"								
YA5C2N-90	3						1.12"	.12"	3.28"								
YA4C2N	1	4 AWG	-	1/2"	1-3/4"	.81"	1.12"	.12"	4.45"	Y1MR (4) Y2MR (4) MY29-3 (2) MY29-11 (2) MRC840 (2) Y644M (1)	W4CVT (2) W4CRT (2) X4CRT (2)	W4CVT (2) W4CRT (2) X4CRT (2)	U4CRT (2) U6CABT (2)	Gray	8	1-3/16"	
YA4C2N-45	2						1.12"	.12"	4.32"								
YA4C2N-90	3						1.12"	.12"	3.30"								
YA4C2TC14	1			1/4"	5/8"	.50"	1.12"	.09"	2.70"								
YA4C2TC14-45	2						1.12"	.09"	2.51"								
YA4C2TC14-90	3						1.12"	.09"	1.54"								
YA4C2TC14E2	1			1/4"	3/4"	.50"	1.12"	.09"	2.83"								
YA4C2TC14E2-45	2						1.12"	.09"	2.64"								
YA4C2TC14E2-90	3						1.12"	.09"	1.66"								
YA4C2TC38	1			3/8"	1"	.56"	1.12"	.08"	3.26"								
YA4C2TC38-45	2						1.12"	.08"	3.03"								
YA4C2TC38-90	3						1.12"	.08"	2.09"								
YA3C2N	1	#3 STR	25	1/2"	1-3/4"	.81"	1.25"	.12"	4.62"	Y1MR (4) Y2MR (4) MY29-3 (2) MY29-11 (2) MRC840 (2) Y644M (1)	W3CRT (2)	W3CRT (2)	U3CRT (2)	White	9	1-5/16"	
YA3C2N-45	2						1.25"	.12"	4.44"								
YA3C2N-90	3						1.25"	.12"	3.32"								
YA3C2TC14	1			1/4"	5/8"	.55"	1.25"	.09"	2.87"								
YA3C2TC14-45	2						1.25"	.09"	2.62"								
YA3C2TC14-90	3						1.25"	.09"	1.55"								
YA3C2TC14E2	1			1/4"	3/4"	.55"	1.25"	.09"	2.99"								
YA3C2TC14E2-45	2						1.25"	.09"	2.75"								
YA3C2TC14E2-90	3						1.25"	.09"	1.68"								
YA3C2TC38	1			3/8"	1"	.58"	1.25"	.08"	3.43"								
YA3C2TC38-45	2						1.25"	.08"	3.16"								
YA3C2TC38-90	3						1.25"	.08"	2.11"								
YA3C2TC38E2	1	3/8"	3/4"	.58"	1.25"	.08"	3.18"										
YA3C2TC38E2-45	2				1.25"	.08"	2.91"										
YA3C2TC38E2-90	3				1.25"	.08"	1.86"										
YA2C2N	1	#2 AWG	35	1/2"	1-3/4"	.81"	1.25"	.12"	4.64"	Y1MR (4) Y2MR (4) MY29-3 (2) MY29-11 (2) MRC840 (2) Y644M (1)	W2CVT (2) W2CRT (2) X2CRT (2)	W2CVT (2) W2CRT (2) X2CRT (2)	U2CRT (2)	Brown	10	1-5/16"	
YA2C2N-45	2						1.25"	.12"	4.46"								
YA2C2N-90	3						1.25"	.12"	3.34"								
YA2C2TC14	1			1/4"	5/8"	.60"	1.25"	.11"	2.86"								
YA2C2TC14-45	2						1.25"	.11"	2.66"								
YA2C2TC14-90	3						1.25"	.11"	1.58"								
YA2C2TC14E2	1			1/4"	3/4"	.60"	1.25"	.11"	2.98"								
YA2C2TC14E2-45	2						1.25"	.11"	2.78"								
YA2C2TC14E2-90	3						1.25"	.11"	1.71"								
YA2C2TC38E2	1			3/8"	3/4"	.60"	1.25"	.11"	3.17"								
YA2C2TC38E2-45	2						1.25"	.11"	2.97"								
YA2C2TC38E2-90	3						1.25"	.11"	1.90"								
YA2C2TC516E2	1			5/16"	3/4"	.60"	1.25"	.11"	3.05"								
YA2C2TC516E2-45	2						1.25"	.11"	2.84"								
YA2C2TC516E2-90	3						1.25"	.11"	1.77"								
YA2C2NTC38	1			3/8"	1-3/4"	.60"	1.25"	.11"	4.17"								
YA2C2NTC38-45	2						1.25"	.11"	3.97"								
YA2C2NTC38-90	3						1.25"	.11"	2.90"								

▲ See tooling section of this catalog for complete tool and die listings.

\* Use PUADP-1 adaptor with "U" -dies in Y46 HYPRESS™.

\*\* P-RT die sets for use in Y46 HYPRESS™ only, PUADP-1 adaptor not required.

\*\*\* The MM<sup>2</sup> conductor sizes listed are the recommendations for Class 2 conductor.

\* Available undrilled. Add suffix "U" to catalog number (example: YA25U).

◆ For applications greater than 2000 Volts consult cable manufacturer for voltage stress relief instructions.

## TWO HOLE HYLUG™ CODE CONDUCTOR LONG BARREL (Continued)

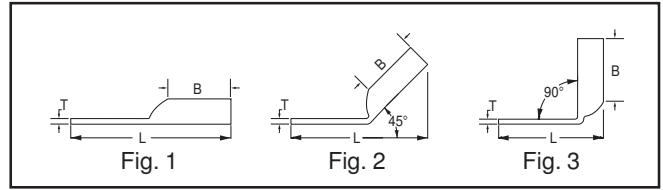

Catalog Number	Fig #	Conductor		Stud Hole Size	Stud Hole Spacing	Tongue Width	Figure Dimensions			▲ Installation Tooling					Wire Strip Length										
		AWG	MM²				(B)	(T)	(L)	Dieless (# of crimps)	Mechanical		Hydraulic			Color Code	Die Index								
											MD6, OUR840, MD7-34R	BCT500HS, Y500CTHS	Y35, Y39, Y750, Y46*, PAT750												
YA2C2TC38	1	#2 AWG	35	3/8"	1"	.60"	1.25"	.11"	3.42"	Y1MR (4) Y2MR (4) MY29-3 (2) MY29-11 (2) MRC840 (2) Y644M (1)	W2CVT (2) W2CRT (2) X2CRT (2)	W2CVT (2) W2CRT (2) X2CRT (2)	U2CRT (2)	Brown	10	1-5/16"									
YA2C2TC38-45	2						1.25"	.11"	3.22"																
YA2C2TC38-90	3						1.25"	.11"	2.14"																
YA2C2TC38E6	1			3/8"	7/8"	.60"	1.25"	.11"	3.30"																
YA2C2TC38E6-45	2						1.25"	.11"	3.10"																
YA2C2TC38E6-90	3						1.25"	.11"	2.02"																
YA2C2TC516E2	1			5/16"	3/4"	.60"	1.25"	.11"	3.05"																
YA2C2TC516E2-45	2						1.25"	.11"	2.84"																
YA2C2TC516E2-90	3						1.25"	.11"	1.77"																
YA1C2N	1	1 AWG	50	1/2"	1-3/4"	.81"	1.38"	.12"	4.82"	Y1MR (4) MY29-3 (2) MY29-11 (2) MRC840 (2) Y644M (1)	W1CVT (2) W1CRT-1 (2) X1CRT-1 (2)	W1CVT (2) W1CRT-1 (2) X1CRT-1 (2)	U1CRT-1 (2) U4CABT (2)	Green	11	1-1/2"									
YA1C2N-45	2						1.38"	.12"	4.58"																
YA1C2N-90	3						1.38"	.12"	3.36"																
YA1C2TC14	1			1/4"	5/8"	.68"	1.38"	.10"	3.03"																
YA1C2TC14-45	2						1.38"	.10"	2.76"																
YA1C2TC14-90	3						1.38"	.10"	1.60"																
YA1C2TC14E2	1			1/4"	3/4"	.75"	1.38"	.10"	3.15"																
YA1C2TC14E2-45	2						1.38"	.10"	2.88"																
YA1C2TC14E2-90	3						1.38"	.10"	1.73"																
YA1C2TC38	1			3/8"	1"	.68"	1.38"	.10"	3.59"																
YA1C2TC38-45	2						1.38"	.10"	3.32"																
YA1C2TC38-90	3						1.38"	.10"	2.16"																
YA252N	1			1/0 AWG	-	1/2"	1-3/4"	.81"	1.38"								.11"	4.81"	MY29-3 (2) MY29-11 (2) MRC840 (4) Y644M (1)	W25VT (4) W25RT (4) X25RT (4)	W25VT (4) W25RT (4) X25RT (4)	U25RT (2) U2CABT (2)	Pink	12	1-7/16"
YA252N-45	2								1.38"								.11"	4.56"							
YA252N-90	3								1.38"								.11"	3.38"							
YA252TC14	1	1/4"	5/8"			.75"	1.38"	.12"	3.05"																
YA252TC14-45	2						1.38"	.12"	2.82"																
YA252TC14-90	3						1.38"	.12"	1.64"																
YA252TC14E2	1	1/4"	3/4"			.75"	1.38"	.12"	3.18"																
YA252TC14E2-45	2						1.38"	.12"	2.94"																
YA252TC14E2-90	3						1.38"	.12"	1.76"																
YA252TC38	1	3/8"	1"			.75"	1.38"	.12"	3.62"																
YA252TC38-45	2						1.38"	.12"	3.38"																
YA252TC38-90	3						1.38"	.12"	2.20"																
YA252TC516	1	5/16"	1"			.75"	1.38"	.12"	3.49"																
YA252TC516-45	2						1.38"	.12"	3.26"																
YA252TC516-90	3						1.38"	.12"	2.08"																
YA252NTC38	1	3/8"	1-3/4"			.75"	1.38"	.12"	4.37"																
YA252NTC38-45	2						1.38"	.12"	4.13"																
YA252NTC38-90	3						1.38"	.12"	2.95"																
YA262N	1	2/0 AWG	70			1/2"	1-3/4"	.83"	1.50"	.12"	4.97"	W26VT (4) W26RT (4) X26RT (4)	W26VT (4) W26RT (4) X26RT (4)	U26RT (2)	Black	13	1-9/16"								
YA262N-45	2								1.50"	.12"	4.69"														
YA262N-90	3								1.50"	.12"	3.41"														
YA262TC14	1			1/4"	5/8"	.83"	1.50"	.12"	3.22"																
YA262TC14-45	2						1.50"	.12"	2.94"																
YA262TC14-90	3						1.50"	.12"	1.66"																
YA262TC14E2	1			1/4"	3/4"	.83"	1.50"	.12"	3.34"																
YA262TC14E2-45	2						1.50"	.12"	3.06"																
YA262TC14E2-90	3						1.50"	.12"	1.79"																

C-53

▲ See tooling section of this catalog for complete tool and die listings.  
\* Use PUADP-1 adaptor with "U" -dies in Y46 HYPRESS™.  
\*\* P-RT die sets for use in Y46 HYPRESS™ only, PUADP-1 adaptor not required.

\*\*\* The MM² conductor sizes listed are the recommendations for Class 2 conductor.  
\* Available undrilled. Add suffix "U" to catalog number (example: YA25U).  
◆ For applications greater than 2000 Volts consult cable manufacturer for voltage stress relief instructions.

## TWO HOLE HYLUG™ CODE CONDUCTOR LONG BARREL (Continued)

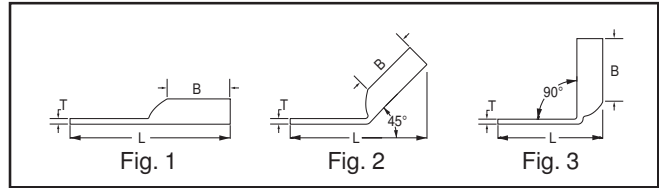

C-54

Catalog Number	Fig #	Conductor		Stud Hole Size	Stud Hole Spacing	Tongue Width	Figure Dimensions			▲ Installation Tooling					Wire Strip Length	
		AWG	MM <sup>2</sup>				(B)	(T)	(L)	Dieless (# of crimps)	Mechanical MD6, OUR840, MD7-34R	Hydraulic BCT500HS, Y500CTHS	Y35, Y39, Y750, Y46*, PAT750	Color Code		Die Index
YA262TC38	1	2/0 AWG	70	3/8"	1"	.83"	1.50"	.12"	3.78"	MY29-3 (2) MY29-11 (2) MRC840 (4) Y644M (1)	W26VT (4) W26RT (4) X26RT (4)	W26VT (4) W26RT (4) X26RT (4)	U26RT (2)	Black	13	1-9/16"
YA262TC38-45	2						1.50"	.12"	3.50"							
YA262TC38-90	3						1.50"	.12"	2.22"							
YA272N	1	3/0 AWG	-	1/2"	1-3/4"	.91"	1.50"	.13"	5.01"							
YA272N-45	2						1.50"	.13"	4.73"							
YA272N-90	3						1.50"	.13"	3.44"							
YA272TC14E2	1			1/4"	3/4"	.91"	1.50"	.12"	3.38"		U27RT (2)					
YA272TC14E2-45	2								3.10"							
YA272TC14E2-90	3								1.82"							
YA272TC38	1			3/8"	1"	.90"	1.50"	.12"	3.82"							
YA272TC38-45	2								3.54"							
YA272TC38-90	3								2.25"							
YA282N	1	4/0 AWG	-	1/2"	1-3/4"	1.02"	1.62"	.14"	5.17"							
YA282N-45	2						1.62"	.14"	4.88"							
YA282N-90	3						1.62"	.14"	3.49"							
YA282TC38	1			3/8"	1"	1.02"	1.62"	.14"	3.99"	U28RT (2)						
YA282TC38-45	2								3.69"							
YA282TC38-90	3								2.30"							
YA282TC14E2	1			1/4"	3/4"	1.02"	1.62"	.14"	3.55"							
YA282TC14E2-45	2								3.25"							
YA282TC14E2-90	3								1.86"							
YA282NTC38	1			3/8"	1-3/4"	1.02"	1.62"	.14"	4.74"		U29RT (2)					
YA282NTC38-45	2								4.44"							
YA282NTC38-90	3								3.05"							
YA292N	1	250 kcmil	-	1/2"	1-3/4"	1.11"	1.62"	.16"	5.21"							
YA292N-45	2						1.62"	.16"	4.94"							
YA292N-90	3						1.62"	.16"	3.52"							
YA292TC38	1			3/8"	1"	1.10"	1.62"	.16"	4.02"	U29RT (2)						
YA292TC38-45	2								3.75"							
YA292TC38-90	3								2.34"							
YA302TC38	1	300 kcmil	150	3/8"	1"	1.20"	2.00"	.16"	4.45"							
YA302TC38-45	2						2.00"	.16"	4.07"							
YA302TC38-90	3						2.00"	.16"	2.37"							
YA302N	1			1/2"	1-3/4"	1.20"	2.00"	.16"	5.64"	U28ART (4)						
YA302N-45	2								5.26"							
YA302N-90	3								3.56"							
YA312N	1	350 kcmil	185	1/2"	1-3/4"	1.29"	2.00"	.18"	5.68"							
YA312N-45	2						2.00"	.18"	5.31"							
YA312N-90	3						2.00"	.18"	3.60"							
YA312TC14E2	1			1/4"	3/4"	1.29"	2.00"	.18"	4.05"	U31RT (4) U29ART (4)						
YA312TC14E2-45	2								3.68"							
YA312TC14E2-90	3								1.97"							
YA312TC38	1			3/8"	1"	1.29"	2.00"	.18"	4.49"							
YA312TC38-45	2								4.12"							
YA312TC38-90	3								2.41"							
YA322N	1	400 kcmil	-	1/2"	1-3/4"	1.38"	2.12"	.19"	5.85"							
YA322N-45	2						2.12"	.19"	5.47"							
YA322N-90	3						2.12"	.19"	3.64"							

▲ See tooling section of this catalog for complete tool and die listings.

\* Use PUADP-1 adaptor with "U" -dies in Y46 HYPRESS™.

\*\* P-RT die sets for use in Y46 HYPRESS™ only, PUADP-1 adaptor not required.

\*\*\* The MM<sup>2</sup> conductor sizes listed are the recommendations for Class 2 conductor.

\* Available undrilled. Add suffix "U" to catalog number (example: YA25U).

◆ For applications greater than 2000 Volts consult cable manufacturer for voltage stress relief instructions.

### TWO HOLE HYLUG™ CODE CONDUCTOR LONG BARREL (Continued)

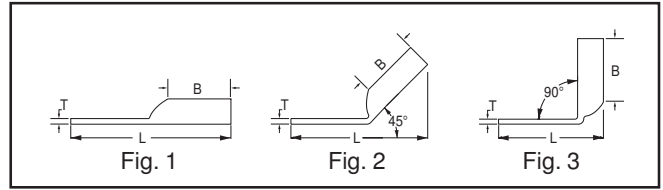
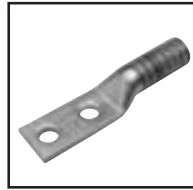

Catalog Number	Fig #	Conductor		Stud Hole Size	Stud Hole Spacing	Tongue Width	Figure Dimensions			Dieless (# of crimps)	▲ Installation Tooling					Wire Strip Length		
		AWG	MM <sup>2</sup>				(B)	(T)	(L)		Mechanical		Hydraulic		Color Code		Die Index	
											MD6, OUR840, MD7-34R	BCT500HS, Y500CTHS	Y35, Y39, Y750, Y46*, PAT750					
YA322TC38	1																	
YA322TC38-45	2	400 kcmil	-	3/8"	1"	1.38"	2.12"	.19"	4.66"	Y644M (1)	W32VT (4)	W32VT (4) W32RT (4)	U32RT (4) U30RT (4)	Blue	19	2-3/16"		
YA322TC38-90	3								2.46"									
YA332N	1								5.93"									2-3/16"
YA332N-45	2	450 kcmil	-	1/2"	1-3/4"	1.48"	2.12"	.21"	5.57"			W33VT (4)	W33VT (4) W33RT (4)	U33RT	Gray	326	2-5/16"	
YA332N-90	3								3.70"									
YA342N	1								6.06"									
YA342N-45	2			1/2"	1-3/4"	1.52"	2.25"	.23"	5.72"									
YA342N-90	3								3.73"									
YA342TC14E2	1								4.46"									
YA342TC14E2-45	2	500 kcmil	240	1/4"	3/4"	1.55"	2.25"	.23"	4.09"			W34VT (4)	W34VT (4) W34RT (4)	U34RT (4) U31ART (4)	Brown	20	2-1/2"	
YA342TC14E2-90	3								2.10"									
YA342TC38	1								4.90"									
YA342TC38-45	2			3/8"	1"	1.55"	2.25"	.23"	4.53"									
YA342TC38-90	3								2.54"									
YA352N	1								6.49"									
YA352N-45	2	550 kcmil	-	1/2"	1-3/4"	1.65"	2.63"	.25"	6.06"			-	-	U35RT (4)	Yellow	21	2-11/16"	
YA352N-90	3								3.77"									
YA362N	1								6.59"									
YA362N-45	2			1/2"	1-3/4"	1.69"			6.17"									
YA362N-90	3	600 kcmil	300				2.69"	.27"	3.81"			-	-	U36RT (4) U32ART (4)	Green	22	2-3/4"	
YA362TC38	1								5.59"									
YA362TC38-45	2			3/8"	1"	1.74"	2.69"	.26"	5.17"									
YA362TC38-90	3								2.81"									
YA372N	1								6.74"									
YA372N-45	2	650 kcmil	-	1/2"	1-3/4"	1.80"	2.81"	.27"	6.29"			-	-	U37RT (4)	Orange	23	2-7/8"	
YA372N-90	3								3.84"									
YA382N	1								6.77"									
YA382N-45	2			1/2"	1-3/4"	1.84"	2.81"	.27"	6.29"									
YA382N-90	3	700 kcmil	-						3.84"									
YA382TC38	1								5.76"									
YA382TC38-45	2			3/8"	1"	1.84"	2.81"	.27"	5.29"		-	-	U38RT (4)	Pink	400	2-7/8"		
YA382TC38-90	3								2.84"									
YA392N	1								6.87"									
YA392N-45	2			1/2"	1-3/4"	1.89"	2.88"	.27"	6.38"									
YA392N-90	3	750 kcmil	-						3.87"									
YA392NT38	1								5.87"									
YA392NT38-45	2			3/8"	1"	1.63"	2.88"	.27"	5.38"		-	-	U39RT (4) P39RT (4) **	Black	24	2-3/4"		
YA392NT38-90	3								2.87"									
YA392TC38	1								5.87"									
YA392TC38-45	2			3/8"	1"	1.91"	2.88"	.27"	5.38"									
YA392TC38-90	3								2.87"									
YA402N	1								6.95"									
YA402N-45	2	800 kcmil	400	1/2"	1-3/4"	1.95"	2.94"	.30"	6.50"		-	-	P40RT (4) **	Orange	25	3"		
YA402N-90	3								3.91"									
YA412N	1								6.96"									
YA412N-45	2	850 kcmil	-	1/2"	1-3/4"	2.01"	2.94"	.31"	6.52"		-	-		Gold	26	3"		
YA412N-90	3								3.93"									

C-55

▲ See tooling section of this catalog for complete tool and die listings.

\* Use PUADP-1 adaptor with "U" -dies in Y46 HYPRESS™.

\*\* P-RT die sets for use in Y46 HYPRESS™ only, PUADP-1 adaptor not required.

\*\*\* The MM<sup>2</sup> conductor sizes listed are the recommendations for Class 2 conductor.

\* Available undrilled. Add suffix "U" to catalog number (example: YA25U).

◆ For applications greater than 2000 Volts consult cable manufacturer for voltage stress relief instructions.

## TWO HOLE HYLUG™ CODE CONDUCTOR LONG BARREL (Continued)

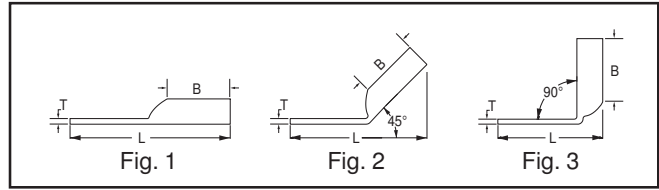
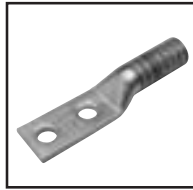

C-56

Catalog Number	Fig #	Conductor		Stud Hole Size	Stud Hole Spacing	Tongue Width	Figure Dimensions			▲ Installation Tooling					Wire Strip Length						
		AWG	*** MM <sup>2</sup>				(B)	(T)	(L)	Dieless (# of crimps)	Mechanical MD6, OUR840, MD7-34R	Hydraulic BCT500HS, Y500CTHS		Y35, Y39, Y750, Y46*, PAT750		Color Code	Die Index				
YA442N	1	1000 kcmil	500	1/2"	1-3/4"	2.17"	3.00"	.33"	7.14"	Y644M (1)	-	-	P44RT (4) **	White	27	3-1/16"					
YA442N-45	2						3.00"	.33"	6.71"												
YA442N-90	3						3.00"	.33"	4.02"												
YA442TC38	1			3/8"	1"	2.19"	3.00"	.33"	6.14"												
YA442TC38-45	2						3.00"	.33"	5.71"												
YA442TC38-90	3						3.00"	.33"	3.02"												
YA452N	1	1250 kcmil	-	1/2"	1-3/4"	2.46"	3.19"	.38"	7.44"	-	-	P45RT (6) **	Yellow	29	3-1/4"						
YA452N-45	2						3.19"	.38"	7.03"												
YA452N-90	3						3.19"	.38"	4.13"												
YA4532N	1	1300 kcmil	-	1/2"	1-3/4"	2.53"	3.19"	.39"	7.48"							-	-	-	Orange	30	3-1/4"
YA4532N-45	2						3.19"	.39"	7.07"												
YA4532N-90	3						3.19"	.39"	4.16"												
YA462N	1	1500 kcmil	-	1/2"	1-3/4"	2.67"	3.19"	.40"	7.55"	-	-	P46RT (6) **	Green	31	3-1/4"						
YA462N-45	2						3.19"	.40"	7.15"												
YA462N-90	3						3.19"	.40"	4.22"												
YA472N	1	1750 kcmil	-	1/2"	1-3/4"	2.90"	3.44"	.42"	7.89"							-	-	-	Gray	33	3-1/2"
YA472N-45	2						3.44"	.42"	7.45"												
YA472N-90	3						3.44"	.42"	4.30"												
YA482N	1	2000 kcmil	-	1/2"	1-3/4"	3.10"	3.44"	.46"	7.98"	-	-	-	Brown	34	3-1/2"						
YA482N-45	2						3.44"	.46"	7.60"												
YA482N-90	3						3.44"	.46"	4.40"												

▲ See tooling section of this catalog for complete tool and die listings.

\* Use PUADP-1 adaptor with "U" -dies in Y46 HYPRESS™.

\*\* P-RT die sets for use in Y46 HYPRESS™ only, PUADP-1 adaptor not required.

\*\*\* The MM<sup>2</sup> conductor sizes listed are the recommendations for Class 2 conductor.

▫ Available undrilled. Add suffix "U" to catalog number (example: YA25U).

◆ For applications greater than 2000 Volts consult cable manufacturer for voltage stress relief instructions.